



Orona 

**We are
your travel
companion.**

CATALOGUE FOR SOLUTIONS

We are Orona, your best travel companion

You are in good hands, the best hands.

We are Orona, a leading business group in sustainable vertical passenger mobility; every day we help more than 25 million people reach their destinations around the world.

Our objective is to bring people together, shortening the distances that separate them.

A leader in elevation that puts the best of its knowledge at your disposal:

- Extensive experience throughout the entire vertical lift value chain
- The plant with the largest production capacity for complete lifts in Europe
- Lifting solutions designed and manufactured in Europe for the world

A committed partner:

- Social commitment, cooperative: people who work with people. We are united by our values.

A number is worth a thousand words

+30,000

units per year production capacity

No. 1

in complete lift production capacity in Europe

60

years of experience

+300,000

lifts worldwide with Orona technology

Getting closer, our way to be and our way of doing.

JOIN THE...

world leader in the distribution of complete lifts with a presence in more than 100 countries through local partners and long-standing relationships.

A MODEL BASED ON...

comprehensive support, providing its partners with first-class technical assistance.

COLLABORATION IN...

solving the major challenges of the **value chain** through access to processes and applications that provide competitiveness and differentiating features.

COMMITMENT...

in ensuring our partners have access to the latest market trends through our continued **investment in R&D**.

Join the Orona Next Experience, where the journey is the destination, live your own story.

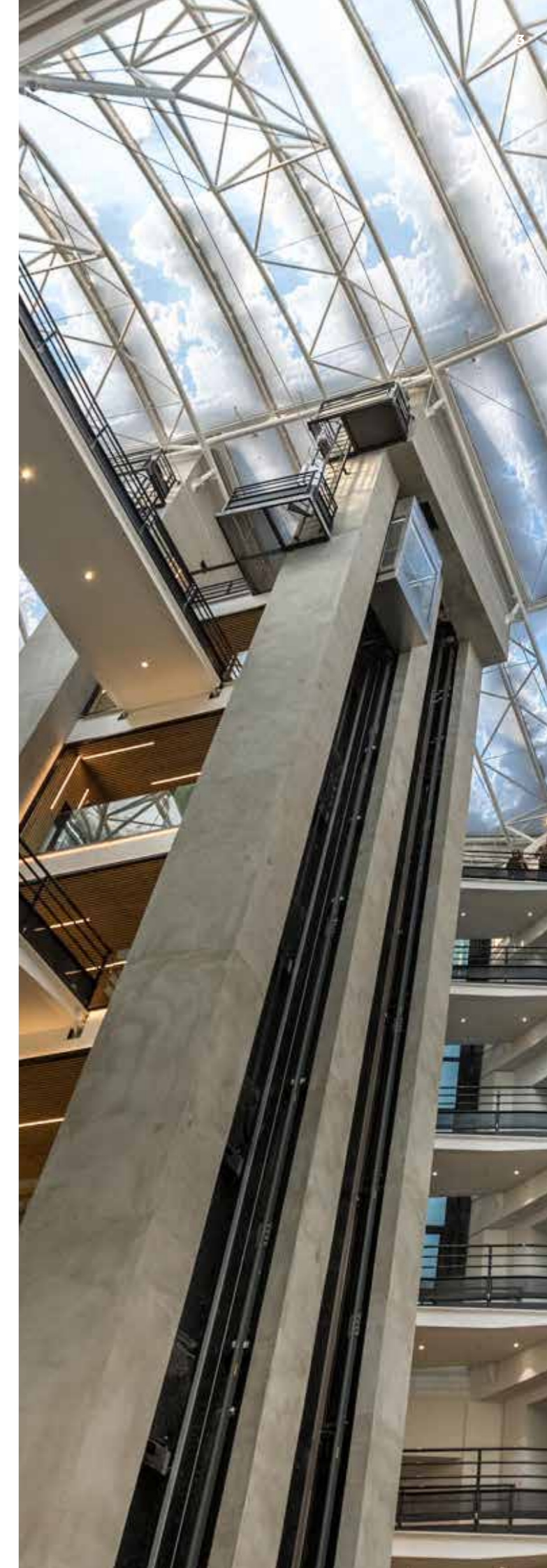

The place where ideas develop..

Orona Ideo is the place where ideas, inspiration and future innovation meet.

Orona Ideo, together with our production plant, embraces the values that underpin Orona's strategy. It's much more than a set of facilities, it is the key to developing and consolidating any idea or project.

Orona Ideo is the ecosystem that brings together all the stakeholders involved in our innovation network, companies, universities and research centres, acting as a driver for increased knowledge and idea sharing which ultimately transforms into results.

...and the place where we make them happen.

Facilities with **the largest production capacity** for complete elevators in Europe.

Orona has two production plants where manufactures equipment and provides service to customers over more than 100 countries in the world.

These production plants are organized in self-managed factories where each of them incorporates its own engineering, procurement logistics, material transformation and quality control..

All the components of the elevator are fully produced in these production plants, ensuring that the whole lift is shipped completely.

This makes us **No. 1 in complete lift production capacity in Europe**, with 30,000 lifts per year.



Orona Next, we elevate your travel experience.

We are living in an increasingly global and digital world, a world in which the physical distance between people can be overcome thanks to technological development, which brings them closer together.

Just imagine having a partner who gives you access, in advance, to disruptive elements that make a difference, who guarantees you an innovative and competitive product, today and tomorrow. A partner who offers you a close involvement at all stages of the process, with comprehensive advice that takes you to the next level.

Orona Next is born, the platform for mobility solutions for people in buildings, which every day fulfils Orona's goal of bringing people together and shortening the distances that separate them. A platform of lift solutions, with a wide range of options to suit your needs.

DESIGNED TO TAKE CARE OF YOU

Solutions that contribute to your well-being on board our lift cars, because our aim is to bring people together and shorten distances, looking after you and your loved ones throughout your trip.

A UNIVERSAL ACCESSIBILITY SPACE

Accessibility elements to ensure that your lift is a universal space, so that it can be used by everyone in safe, comfortable conditions and in the most natural and independent manner.

WE PUT ALL OUR ENERGY AT THE SERVICE OF SUSTAINABILITY

We design and integrate all systems to reduce the energy consumption of your solution, thinking about today and tomorrow, because sustainability is a part of who we are.



Designed to take care of you.

Your health and that of your loved ones is important to us. That's why at Orona we have developed a series of solutions that contribute to your well-being:



Air purifier

The air purifier with nanoe™ X*1) technology inhibits the activity of viruses*2), ensuring that the lift car air is clean and guaranteeing your well-being. It has a highly efficient purifying function.

nanoe™ X technology is based on a multitude of hydroxyl radicals grouped into water droplets that inhibit viruses, transforming their protein.

Furthermore, the high level of air renewal in a lift reduces the risk of exposure. The greater the lift ventilation rate, the lower the accumulated dose to which passengers will potentially be exposed.

* 1) nanoe™ X is a registered trademark of Panasonic Corporation.

* 2) Test results may vary according to the exposure area and air quality. Further information at www.orona-group.com/en-gb/orona-next/

Anti-bacterial car walls

The innovative materials used on the lift surface keep your lift car clean, thanks to the antibacterial surface.

Antimicrobial handrails

The handrail is the element used to facilitate access to the lift car, which is why we protect our handrails with an antimicrobial treatment that prevents both bacteria and viruses.



A space with universal accessibility

Orona Next includes accessibility elements to ensure that your lift is a universal space, so that it can be used by everyone in safe, comfortable conditions and in the most natural and independent manner.

Included features • Accessibility pack



PRECISE STOPPING
Optimises accessibility when entering or exiting the lift.

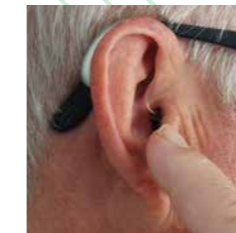

INDUCTIVE/ACOUSTIC COUPLING
For people with hearing disabilities.

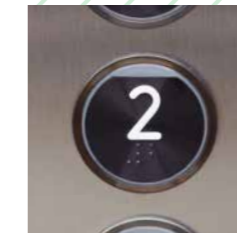

BRaille PUSH BUTTON



CAR PUSH BUTTON
Model with additional contrast.



GONG IN CAR AND ON LANDINGS
Notification of the lift reaching its destination through acoustic and visual signal.



ERGONOMIC HANDRAIL
Heights appropriate for users either standing or in wheelchairs.

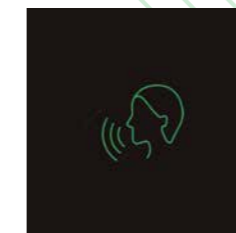

MULTILINGUAL VOICE SYNTHESISER
Announces floor level, direction of travel and door operation.



SAFETY MIRROR ON THE BACK WALL
Facilitates detection of obstacles when exiting..



PHOTOELECTRIC CURTAIN
Avoids the risk of the doors hitting, allowing a safer use of the lift.



AUDIBLE AND VISUAL PUSH BUTTON INFORMATION
Their location, design, colour and visual / tactile (Braille) / sound operation comply with the EN 81-70 standard.

Other configurable options

- Tip-up seat.
- Visible direction arrow that displays the lift's direction of travel prior to its departure.
- Rear-view mirror.

Minimum car dimensions

We have cars with dimensions in accordance with EN 81-70. Consult standard dimensions tables.

All our energy at the service of sustainability.

We have reduced energy consumption by up to 75%.

At Orona, we work responsibly and sustainably throughout the whole value chain, designing environmentally-friendly mobility solutions and promoting the development of a circular economy.



Class AAA solutions for all categories.

As a result of the high energy performance achieved by LED lightning and the standby mode system, **Orona Next** solutions have been granted class AAA energy certification in agreement with VDI/ISO standards.

We were the 1st company in the sector to receive Eco-design certification ISO 14006

Since 2008, the year in which we started to eco-design lifts according to UNE 150301, we have accumulated milestones and experience in eco-efficiency, reflecting our commitment to sustainability.

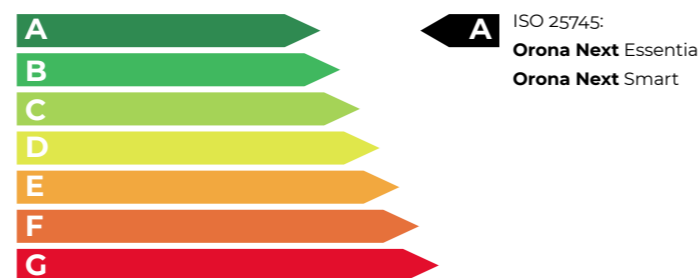

Environmental Product Declaration

Our **Orona Next** models have Environmental Product Declarations (EPD) certified under standard ISO 14025. We make information related to the environmental performance of our products available to you, based on a Life Cycle Analysis (LCA) performed according to the Eco-design standard ISO 14006.

Organisational Carbon Footprint

As part of our commitment to Sustainability, we have Carbon Footprint certification according to ISO 14064, and we exercise transparency in relation to the emission of greenhouse gases resulting from our activity. Thus, we assume the yearly commitment to reduce emissions in our whole value chain.



Alternatives for reducing energy consumption by your lift.

- ORONA GRID REGEN. ENERGY REGENERATION SYSTEM.**
 - Every time the car goes up with a light load or down with a heavy one, instead of consuming it, the lift motor generates energy.
 - The energy generated by the lift can be used by other devices connected to the same network or (depending on the country) returned to the network, reducing consumption and contributing to cost savings.
- GEARLESS LOW-ENERGY DRIVE**
 - Our machine has one of the highest energy efficiencies in the market, reaching 90% performance.
- EFFICIENT LED LIGHTING AND AUTOMATIC CAR LIGHTING SWITCH-OFF**
 - Orona solutions include these two features out of the box, saving up to 80%.
 - Its useful life is up to 10 times longer.
- LIFT STANDBY MODE**

When the lift is on stand-by:

 - Car digital elements and signalling are dimmed.
 - The power elements (frequency inverter) switch to stand-by mode.
 - The car fan switches off.

Be **free**: choose the solution that best meets your needs.



| Model | Description of solution groups | Speed | Load Capacity | | Maximum travel | | Entrances | |
|--------------------------------|---|----------|-----------------|----------|----------------|----|-----------|--------|
| | | | m/s | kg | persons | m | stops | 2x180° |
| Orona Next Essentia | Functionality and comfort within your reach | 1 | 320-400-450-630 | 4-5-6-8 | 40 | 14 | ○ | ○ |
| Orona Next Smart | Customised comfort | 1-1.6 | 320 to 1000 | 4 to 13 | 50-60 | 21 | ○ | * |
| Orona Next Smart+ | Quicker, stronger, taller | 1-1.6 | 630 to 2500 | 8 to 33 | 50-75 | 32 | ○ | * |
| Orona Next Rise | Solutions for high-rise buildings | 1.75-2.5 | 450* to 1600 | 6* to 21 | 130 | 64 | ○ | |
| Orona Next Flex | Fits in any shaft | 1 | 180 to 630 | 2 to 8 | 40 | 14 | ○ | ○ |

*Consult technical specifications ○ Optional

Essentia

Functionality & comfort within your reach.

Our best-selling solution.

General Specifications

| | |
|------------------------------|--|
| Load | 320 - 400 - 450 - 630 kg 320 - 450 kg (Single-phase) |
| Capacity | 4 - 5 - 6 - 8 Kg 4 - 6 persons (Single-phase) |
| Speed | 1 m/s / 0.6 m/s (single-phase) |
| Maximum Travel | 40 m / 25 m (single-phase) |
| Maximum Floors Served | 14 Floors |
| Machine-room Option | Yes |
| Entrances | 1 Front 2 Open through 2 Front & side |
| Drive System | Regulated gearless (180 stars per hour) |
| Controller | ARCA III controller, low energy consumption multiprocessor |
| Door Types | Automatic side-opening Automatic centre-opening |
| Clear door opening | 700 / 800 / 900 mm |
| Door Height | 2,000 / 2,100 mm |
| Car Dimensions | Standard |
| Internal Car Height | 2,100 / 2,200 mm |
| Power Supply | Three-phase / Single-phase |

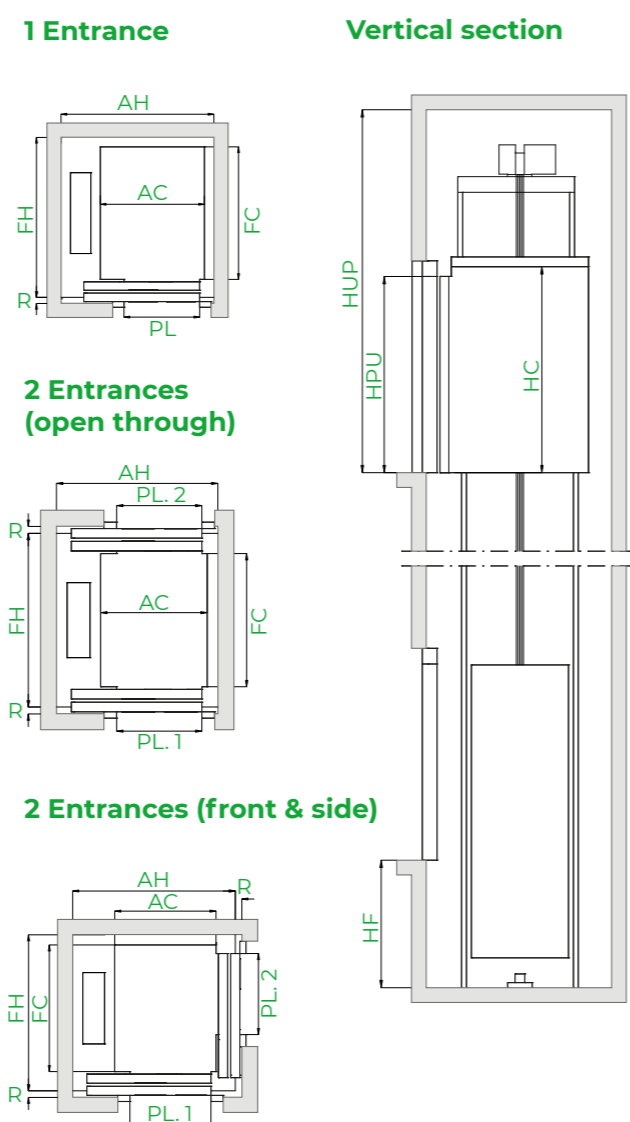

*Note: The diagrams are for guidance only.

Standard dimensions*

| Load / Capacity | | Car (mm) | | | Entrances | | Lift Shaft ^o (mm) | | | | HF Pit | HUP Head-room |
|-----------------|--------|----------|----------|------------------|---------------|------------------|------------------------------|-----------------------|------------------------------|-----------------------|--------------------------|------------------------------|
| | | | | | | | 2-panel side-opening doors | | 2-panel centre-opening doors | | | |
| Persons | Q Load | AC Width | FC Depth | PL Clear opening | Accessibility | No. of entrances | AH ¹ Width | FH ² Depth | AH Width | FH ³ Depth | HF Pit | HUP Head-room |
| | | | | | | | 4 | 320 kg | 825 | 1,100 | | |
| | | | | | | 2x180° | 1,450 | 1,500 | - | 1,400 | | |
| 5 | 400 kg | 850 | 1,200 | 800 | - | 1 | 1,370 | 1,450 | - | - | 1,000 (850) ⁴ | 3,400 |
| | | | | | | 2x90° | 1,535 | 1,450 | - | - | | |
| 6 | 450 kg | 1,000 | 1,250 | 800 | ♿ | 1 | 1,500 | 1,500 | 1,800 | 1,450 | 1,000 (850) ⁴ | 3,400 (3,000) ⁵⁻⁶ |
| | | | | | | 2x180° | 1,650 | - | 1,550 | | | |
| | | 1,000 | 1,300 | 800 | ♿ | 1 | 1,550 | 1,550 | 1,800 | 1,500 | 1,600 | |
| | | | | | | 2x180° | 1,700 | - | 1,600 | | | |
| 8 | 630 kg | 1,100 | 1,400 | 900 | ♿ | 1 | 1,600 | 1,650 | 2,000 | 1,600 | 1,000 (850) ⁴ | 3,400 (3,000) ⁵ |
| | | | | | | 2x180° | 1,800 | - | 1,700 | | | |
| | | 1,200 | 1,250 | 900 | ♿ | 1 | 1,700 | 1,500 | 2,000 | 1,450 | 1,550 | |
| | | | | | | 2x180° | 1,650 | - | 1,550 | | | |
| | | | | | | 2x90° | 1,825 | 1,575 | - | - | | |

- o Minimum plumb measurements
- 1 Accessible space below the pit (Counterweight with safety gear) add 50 mm to AH
- 2 R=60 mm, lift shaft depth with 2-panel side-opening doors, resting 60 mm on the landing
- 3 R=40 mm, lift shaft depth with 2-panel central-opening doors, resting 40 mm on the landing
- 4 HF reduced pit optional 850 mm
- 5 Minimum HUP for internal car height (HC) of 2,100 mm
- 6 HUP reduced headroom optional only for 6 and 8 persons
- 7 Not available 2x90° with big doors

*The information is not contractually binding and is subject to the conditions of the shaft





MRL
Machine-room-less solution, with reduced headroom (optional).



Optimised passenger unit
Saves space and reduces weight, providing safety, ergonomics and speed during assembly processes.



Accessible space below the pit
Adapts the lift to suit buildings requiring an accessible space below the pit.

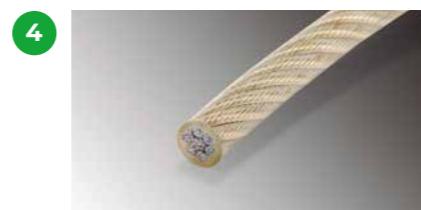

Traction ropes
They replace traditional steel ropes. As a result of their lighter weight, longer lifespan and greater flexibility, it is possible to use a more compact machine.



Drive
Compact, quiet, gearless, energy-efficient, inverter-drive permanent-magnet motor electrical machine.



Doors
With a compact permanent-magnet motor, which allows fast, precise and quiet opening and closing motions, raising current feature standards, with pre-opening and/or light curtain. Optional Solid Door for higher flow situations.



Automatic rescue system
With floor level indication to ensure fast, efficient and safe evacuation of passengers in the event of an emergency. As an option the system can incorporate a fully automatic rescue device to evacuate passengers in the event of a power failure.



Smart Customised comfort

Solution that can be adapted to all types of buildings and users. A sure investment to meet the needs of each of your projects.

General Specifications

| | |
|------------------------------|--|
| Load | 320 to 1,000 kg |
| Capacity | 4 to 13 persons |
| Speed | 1 - 1.6 m/s |
| Maximum Travel | 50 - 60 m |
| Maximum Floors Served | 16 - 21 floors |
| Machine-room Option | Yes |
| Entrances | 1 Front 2 Open through 2 Front & side (<700kg) |
| Drive System | Regulated gearless (240 stars per hour) |
| Controller | ARCA III controller, low energy consumption multiprocessor |
| Door Types | Automatic side-opening Automatic centre-opening |
| Clear door opening | From 700 to 1,000 mm (at intervals of 100 mm) |
| Door Height | 2,000 / 2,100 / 2,200 / 2,300 mm |
| Car Dimensions | Parametric |
| Internal Car Height | 2,100 / 2,200 / 2,300 / 2,400 mm |

1 Entrance

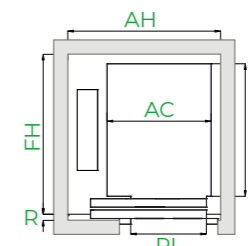

2 Entrances (open through)

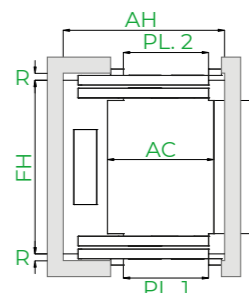

2 Entrances (front & side)

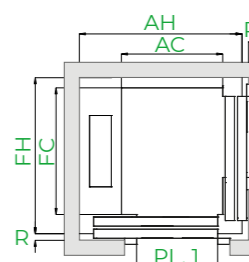

Vertical section

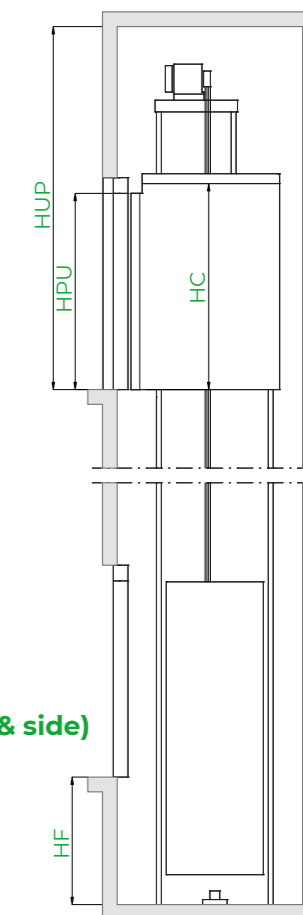

*Note: The diagrams are for guidance only. Dimensions for 1 entrance. Car width and depth variable, in 5 mm increments. For simplification, table samples show increments of 100 mm.

Customised solution, examples of dimensions*

| Load / Capacity | | | Car (mm) | | | Entrances | | Lift Shaft ⁰ (mm) | | | | HF Pit | HUP ⁵ Headroom |
|-----------------|---------|----------|--------------------|--------------------|------------------|---------------|------------------|------------------------------|-----------------------|-------------------------------|-----------------------|--------------------------|---------------------------|
| Speed | Persons | Q Load | AC Width | FC Depth | PL Clear opening | Accessibility | No. of entrances | Two-panel side-opening doors | | 2-panel central-opening doors | | | |
| | | | | | | | | AH ¹ Width | FH ² Depth | AH Width | FH ³ Depth | | |
| 1 m/s | 4 | 320 kg | 825 | 1,100 | 700 | - | 1 2x180° | 1,300 | 1,350 1,500 | - | - | 1,000 (830) ⁴ | 3,400 |
| | 6 | 450 kg | 1,000 | 1,250 | 800 | ♿ | 1 2x180° | 1,450 | 1,500 1,650 | 1,725 | 1,450 1,550 | | |
| | 8 | 630 kg | 1,100 | 1,400 | 900 | ♿ | 1 2x180° | 1,600 | 1,675 1,850 | 1,925 | 1,625 1,750 | | |
| | 10 | 800 kg | 1,350 ⁷ | 1,400 | 900 | | 1 2x180° | 1,825 | 1,675 1,850 | 1,925 | 1,625 1,750 | | |
| | | | | | | | 1 2x90° | 1,970 | 1,685 1,650 | 2,045 | 1,625 1,750 | | |
| | 13 | 1,000 kg | 1,600 ⁸ | 1,400 ⁸ | 1,000 | | ♿ | 1 2x180° | 2,075 | 1,675 1,850 | 2,150 | | |
| | | | | | | 1 2x90° | | 2,045 | 1,885 | - | - | | |
| | | | | | | 1 2x180° | | 1,775 | 2,375 2,550 | 2,125 | 2,300 2,400 | | |
| | | | | | | 1 2x90° | | 1,745 | 2,385 | - | - | | |
| | 1.6 m/s | 4 | 320 kg | 825 | 1,100 | 700 | - | 1 2x180° | 1,325 | 1,350 1,500 | - | | |
| 6 | | 450 kg | 1,000 | 1,250 | 800 | ♿ | 1 2x180° | 1,475 | 1,500 1,650 | 1,725 | 1,450 1,550 | | |
| 8 | | 630 kg | 1,100 | 1,400 | 900 | ♿ | 1 2x180° | 1,625 | 1,675 1,850 | 1,925 | 1,625 1,750 | | |
| 10 | | 800 kg | 1,350 | 1,400 | 900 | | 1 2x180° | 1,850 | 1,675 1,850 | 1,925 | 1,625 1,750 | | |
| | | | | | | | 1 2x180° | 2,100 | 1,675 1,850 | 2,175 | 1,625 1,750 | | |
| 13 | | 1,000 kg | 1,600 | 1,400 | 1,000 | | 1 2x180° | 2,100 | 1,675 1,850 | 2,175 | 1,625 1,750 | | |
| | | | | | | 1 2x180° | 1,775 | 2,375 2,550 | 2,125 | 2,300 2,400 | | | |

0 Minimum plumb measurements

- 1 Accessible space below the pit (Counterweight with safety gear), add 115 mm to AH
- 2 R=60 mm, lift shaft depth with 2-panel side-opening doors, resting 60 mm on the landing
- 3 R=40 mm, lift shaft depth with 2-panel centre-opening doors, resting 40 mm
- 4 HF reduced pit optional 830 mm

5 Minimum HUP for internal car height (HC) of 2,100 mm

- 6 HUP optional reduced (HUP=HC+900). Consult availability of car dimensions
- 7 For 800 Kg to 90° AC 1,325 mm
- 8 For 1,000 Kg to 90° AC 1,400 mm FC 1,600 mm
- 9 For 1,000 Kg to 90° PL 900 mm

* The information is not contractually binding and is subject to the conditions of the shaft

Customised car dimensions

| Car width | | | | | | | | | | Car depth | | | | | | | | | | |
|-----------|--|--|--|--|--|--|--|-------|-------|--------------------|-------|-------|-------|-------|-------|-------|-------|----|-----|-----|
| | | | | | | | | | | Clear door opening | | | | | | | | | | |
| | | | | | | | | 13 | 12 | 1,600 | | | | | | | | | | |
| | | | | | | | | 13 | 13 | 1,500 | | | | | | | | | | |
| | | | | | | | | 13 | 13 | 1,400 | | | | | | | | | | |
| | | | | | | | | 13 | 12 | 1,300 | | | | | | | | | | |
| | | | | | | | | 13 | 13 | 1,200 | | | | | | | | | | |
| | | | | | | | | 13 | 13 | 1,100 | | | | | | | | | | |
| | | | | | | | | 12 | 12 | 1,000 | | | | | | | | | | |
| | | | | | | | | 11 | 10 | 900 | | | | | | | | | | |
| | | | | | | | | 2,100 | 2,000 | 1,900 | 1,800 | 1,700 | 1,600 | 1,500 | 1,400 | 1,300 | 1,200 | mm | 800 | 900 |



Drive
Compact, quiet, gearless, energy-efficient, inverter-drive permanent-magnet motor electrical machine.



Solid doors
Extra robust doors which improve sound-proofing inside and outside the lift and which are specially sized for an intense flow of people.



Parametric / Flexible
The parametric dimensions offer the possibility of adapting the lift to most potential space-based needs (optional).



Accessible space below the pit
Adapts the lift to suit buildings requiring an accessible space below the pit (optional).



Reduced headroom
Optional system that allows reducing the space required above the last floor in the building while ensuring maximum safety and protection for maintenance technicians.

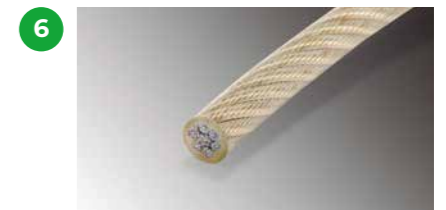

Traction ropes
They replace traditional steel ropes. As a result of their lighter weight, longer lifespan and greater flexibility, it is possible to use a more compact machine with a more efficient and eco-friendly motor.



Automatic rescue system
With floor level indication to ensure fast, efficient and safe evacuation of passengers in the event of an emergency. As an option, the system can incorporate a fully-automatic rescue device to evacuate passengers in the event of a power failure.



Smart+ Features that can satisfy every need.

Quicker, stronger, taller. Reliability and durability in transport, guaranteeing the safety of all users.

General Specifications

| | |
|------------------------------|--|
| Load | 630 to 2,500 kg |
| Capacity | 8 to 33 persons |
| Speed | 1 - 1.6 m/s |
| Maximum Travel | 50 - 75 m |
| Maximum Floors Served | 32 floors |
| Machine-room Option | Yes |
| Entrances | 1 Front 2 Open through 2 Front & side (<1,250kg) |
| Drive System | Regulated gearless (240 stars per hour) |
| Controller | ARCA III controller, low energy consumption multiprocessor |
| Door Types | Automatic side-opening Automatic centre-opening |
| Clear door opening | From 800 to 1,600 mm (in 100 mm increments) |
| Door Height | 2,000 / 2,100 / 2,200 / 2,300 mm |
| Car Dimensions | Parametric |
| Internal Car Height | 2,100 / 2,200 / 2,300 / 2,400 mm |

Standard Optional

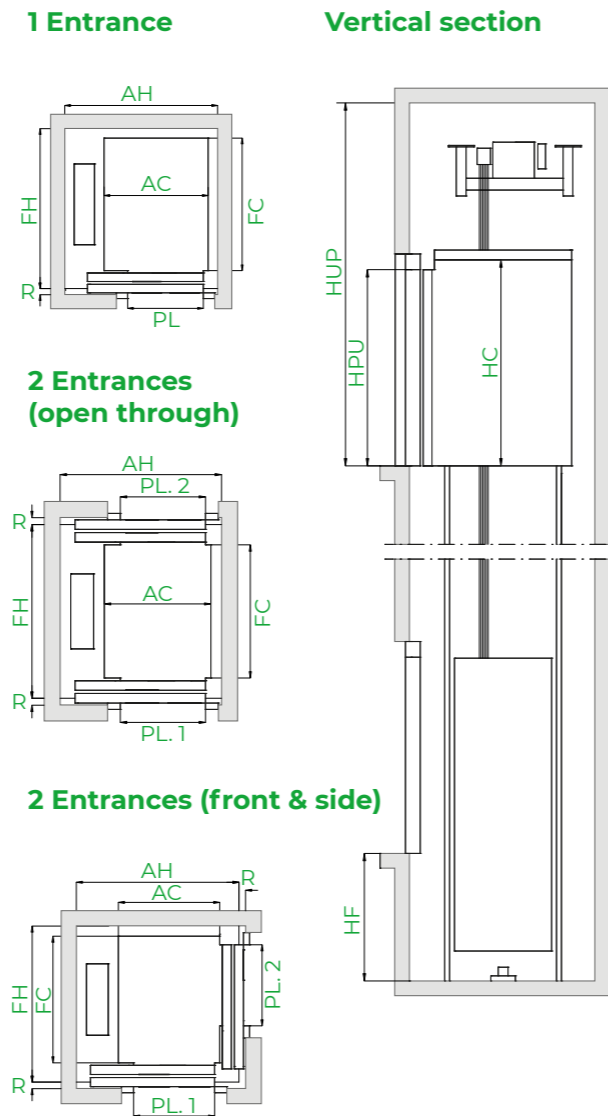

*Note: The diagrams are for guidance only. Dimensions for 1 entrance. Car width and depth variable, in 5 mm increments. For simplification, table samples show increments of 100 mm.

Customised solution, examples of dimensions*

| Speed | Load / Capacity | | Car (mm) | | | Lift Shaft° (mm)* | | | | | | | |
|---------|-----------------|----------|----------|----------|------------------|--------------------|--------|-----------------------|-----------------------|----------|-----------------------|--------|---------------|
| | Persons | Q Load | AC Width | FC Depth | PL Clear opening | Side-opening doors | | | Centre-opening doors | | | | |
| | | | | | | Entrance | | AH ¹ Width | FH ² Depth | AH Width | FH ³ Depth | HF Pit | HUP Head-room |
| 1 m/s | 8 | 630 kg | 1,100 | 1,400 | 900 | 1 | 2x180° | 1,700 | 1,675 | 1,950 | 1,625 | 1,050 | 3,550 |
| | | | | | | | | 1,850 | 1,750 | | | | |
| | 10 | 800 kg | 1,350 | 1,400 | 900 | 1 | 2x180° | 1,975 | 1,675 | 1,975 | 1,625 | 1,050 | 3,550 |
| | | | | | | | | 1,850 | 1,750 | | | | |
| | 13 | 1,000 kg | 1,600 | 1,400 | 1,000 | 1 | 2x180° | 2,225 | 1,675 | 2,225 | 1,625 | 1,050 | 3,550 |
| | | | | | | | | 1,850 | 1,750 | | | | |
| | 17 | 1,275 kg | 1,200 | 2,300 | 1,100 | 1 | 2x180° | 1,775 | 2,375 | - | - | 1,050 | 3,550 |
| | | | | | | | | 2,550 | 2,600 | | | | |
| | 21 | 1,600 kg | 1,700 | 1,950 | 1,000 | 1 | 2x180° | 1,935 | 2,600 | - | - | 1,150 | 3,600 |
| | | | | | | | | 2,750 | 2,700 | | | | |
| 24 | 1,800 kg | 2,350 | 1,600 | 1,200 | 1 | 2x180° | - | - | 2,450 | 2,200 | 1,150 | 3,600 | |
| | | | | | | | 2,850 | 2,300 | | | | | |
| 1.6 m/s | 8 | 630 kg | 1,100 | 1,400 | 900 | 1 | 2x180° | - | - | 3,150 | 1,950 | 1,465 | 3,650 |
| | | | | | | | | 2,160 | 2,050 | | | | |
| | 10 | 800 kg | 1,350 | 1,400 | 900 | 1 | 2x180° | - | - | 3,150 | 2,160 | 1,465 | 3,650 |
| | | | | | | | | 2,260 | 2,260 | | | | |
| | 13 | 1,000 kg | 1,600 | 1,400 | 1,000 | 1 | 2x180° | - | - | 3,150 | 2,050 | 1,465 | 3,650 |
| | | | | | | | | 2,260 | 2,260 | | | | |
| | 17 | 1,275 kg | 1,200 | 2,300 | 1,100 | 1 | 2x180° | - | - | 3,150 | 2,050 | 1,465 | 3,650 |
| | | | | | | | | 2,260 | 2,260 | | | | |
| | 21 | 1,600 kg | 1,700 | 1,950 | 1,000 | 1 | 2x180° | - | - | 2,450 | 2,200 | 1,250 | 3,765 |
| | | | | | | | | 2,300 | 2,300 | | | | |
| 24 | 1,800 kg | 2,350 | 1,600 | 1,200 | 1 | 2x180° | - | - | 2,450 | 2,200 | 1,250 | 3,765 | |
| | | | | | | | 2,300 | 2,300 | | | | | |
| 26 | 2,000 kg | 2,350 | 1,700 | 1,200 | 1 | 2x180° | - | - | 3,150 | 2,050 | 1,600 | 3,790 | |
| | | | | | | | 2,260 | 2,260 | | | | | |
| 33 | 2,500 kg | 1,800 | 2,700 | 1,300 | 1 | 2x180° | - | - | 3,150 | 2,050 | 1,600 | 3,790 | |
| | | | | | | | 2,260 | 2,260 | | | | | |

- 0 Minimum plumb measurements
- 1 Accessible space below the pit (Counterweight with safety gear) add 50 mm to AH
- 2 Shaft depth with door tracks projecting 60 mm on the landing
- 3 Shaft depth with door tracks projecting 40 mm on the landing
- 4 Minimum HUP for internal car height (HC) of 2,100 mm

* The information is not contractually binding and is subject to the conditions of the shaft

Rise

The sky is the limit.

Guarantees comfortable and safe mobility for long travel times, improving the user experience throughout the trip.

General Specifications

| | |
|------------------------------|--|
| Load | 450 (MR)/630 - 1,600 kg |
| Capacity | 6(MR)/8 to 21 persons |
| Speed | 1.6(MR)/1.75 - 2 - 2.5 m/s |
| Maximum Travel | 130 m |
| Maximum Floors Served | 64 floors |
| Machine-room Option | Yes |
| Entrances | 1 Front 2 Open through |
| Drive System | Regulated gearless (240 stars per hour) |
| Controller | ARCA III controller, low energy consumption multiprocessor |
| Door Types | Automatic side-opening Automatic centre-opening |
| Clear door opening | From 900 to 1,200 mm (in increments of 100 mm) |
| Door Height | 2,000 / 2,100 / 2,200 / 2,300 mm |
| Car Dimensions | Parametric |
| Internal Car Height | 2,100 / 2,200 / 2,300 / 2,400 mm |

1 Entrance

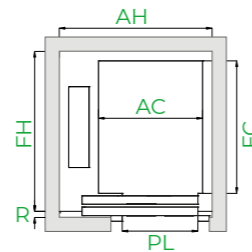

Vertical section

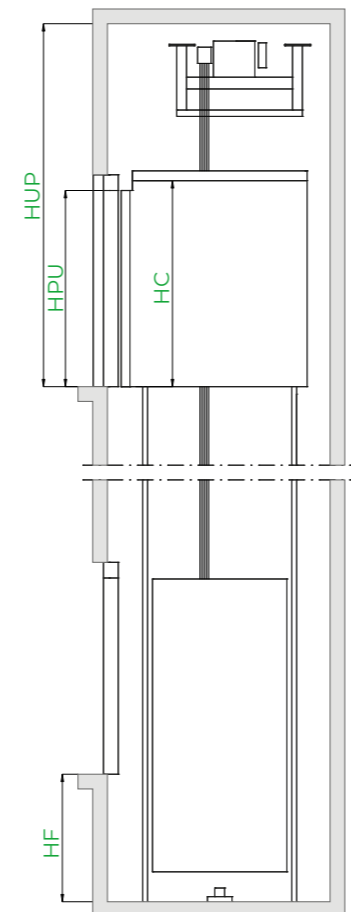

2 Entrances (open through)

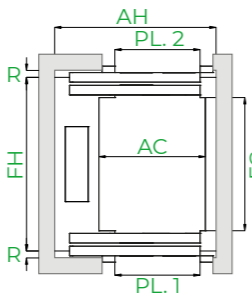

Customised solution, examples of dimensions*

| Load / Capacity | | | Car (mm) | | | Lift Shaft° (mm)* | | | | | | | |
|--|---------|----------|----------|----------|------------------|--------------------|------------------|-----------|-----------|----------------------|-----------|-----------------------------------|--|
| Speed | Persons | Q Load | AC Width | FC Depth | PL Clear opening | Side-opening doors | | | | Centre-opening doors | | | |
| | | | | | | Entrance | | AH¹ Width | FH² Depth | AH³ Width | FH³ Depth | HF Pit | HUP Head-room |
| | | | | | | Accessibility | No. of entrances | | | | | | |
| 1.75 m/s - 2 m/s - 2.5 m/s | 8 | 630 kg | 1,100 | 1,400 | 900 | ♿ | 1 | 1,850 | 1,900 | 1,950 | 1,800 | 1,685 - 1,790 - 2,150 | (4) 4,430 - (5) 4,570 - (6) 4,800 |
| | | | | | | | 2x180° | 2,000 | 2,100 | 1,950 | | | |
| | 10 | 800 kg | 1,350 | 1,400 | 900 | | 1 | 2,100 | 1,900 | 2,100 | 1,800 | | |
| | | | | | | | 2x180° | 2,000 | 2,350 | 1,950 | | | |
| | 13 | 1,000 kg | 1,600 | 1,400 | 1,000 | | 1 | 2,350 | 1,900 | 2,350 | 1,800 | | |
| | | | | | | | 2x180° | 2,000 | 2,350 | 1,950 | | | |
| | | | 1,100 | 2,100 | 1,000 | 1 | 1,850 | 2,400 | 2,150 | 2,350 | | | |
| | | | | | | 2x180° | 2,550 | 2,450 | 2,450 | | | | |
| | 17 | 1,275 kg | 2,000 | 1,400 | 1,100 | ♿ | 1 | 2,800 | 1,900 | 2,800 | 1,800 | 1,905 - 2,005 - 2,150 | |
| | | | | | | | 2x180° | 2,000 | 2,800 | 1,950 | | | |
| | | | 1,200 | 2,300 | 1,100 | | 1 | 2,000 | 2,600 | 2,350 | 2,550 | | |
| | | | | | | | 2x180° | 2,750 | 2,650 | 2,650 | | | |
| 2,100 | | | 1,600 | 1,100 | 1 | | 2,900 | 1,950 | 2,900 | 1,900 | | | |
| | | | | | 2x180° | | 2,100 | 2,900 | 2,050 | 2,150 | | | |
| 1,400 | 2,400 | 1,200 | 1 | 2,200 | 2,700 | 2,550 | 2,650 | | | | | | |
| | | | 2x180° | 2,850 | 2,750 | 2,750 | | | | | | | |

- 0 Minimum plumb measurements
- 1 Considered without safety gear at counterweight (35 mm clearance to door frame)
In the case of safety gear at counterweight (98 mm clearance to door frame)
- 2 Lift shaft depth with door tracks projecting 60 mm on the landing (adapted to space 50)
- 3 Lift shaft depth with door tracks projecting 40 mm on the landing (adapted to space 34)
- 4 (1.75m/s) Minimum HUP (HUP=HCext+2130) *Table HC=2,300, with sliding shoes
- 5 (2m/s) Minimum HUP (HUP=HCext+2270) *Table HC=2,300
- 6 (2.5m/s) Minimum HUP (HUP=HCext+2500) *Table HC=2,300

* The information is not contractually binding and is subject to the conditions of the shaft

Customised car dimensions

| Car depth | | | | | | | | | | | | | Car width | | | | | | | | | | |
|-----------|-------|-------|-------|-------|-------|-------|-------|-------|-------|-------|-------|-------|-----------|-------|-----|-----|-------|-------|-------|-------|-------|-------|-------|
| | | | | | | | | | | | | | 2,100 | | | | | | | | | | |
| | | | | | | | | | | | | | 2,000 | | | | | | | | | | |
| | | | | | | | | | | | | | 1,900 | | | | | | | | | | |
| | | | | | | | | | | | | | 1,800 | | | | | | | | | | |
| | | | | | | | | | | | | | 1,700 | | | | | | | | | | |
| | | | | | | | | | | | | | 1,600 | | | | | | | | | | |
| | | | | | | | | | | | | | 1,500 | | | | | | | | | | |
| 21 | 21 | 20 | 19 | 28 | 17 | 16 | 15 | 14 | 13 | 13 | 12 | 11 | 10 | 1,400 | | | | | | | | | |
| 20 | 19 | 18 | 17 | 16 | 16 | 15 | 14 | 13 | 12 | 11 | 10 | 9 | 8 | 1,300 | | | | | | | | | |
| 19 | 18 | 17 | 16 | 15 | 14 | 13 | 13 | 12 | 11 | 10 | 9 | 9 | 8 | 1,200 | | | | | | | | | |
| | | | | | | | | | | | | | 1,100 | | | | | | | | | | |
| | | | | | | | | | | | | | 1,000 | | | | | | | | | | |
| | | | | | | | | | | | | | 900 | | | | | | | | | | |
| 2,500 | 2,400 | 2,300 | 2,200 | 2,100 | 2,000 | 1,900 | 1,800 | 1,700 | 1,600 | 1,500 | 1,400 | 1,300 | 1,200 | mm | 800 | 900 | 1,000 | 1,100 | 1,200 | 1,300 | 1,400 | 1,500 | 1,600 |

Car depth

Clear door opening

Flex Fits in any shaft.

Finite space, infinite solutions

General Specifications

| | |
|------------------------------|---|
| Load | 180 to 630 kg 180 to 450 kg (Single-phase) |
| Capacity | 2 to 8 persons 2 to 6 persons (Single-phase) |
| Capacity | 1 m/s / 0.6 m/s (Single-phase) |
| Maximum Travel | 40 m / 25 m (Single-phase) |
| Maximum Floors Served | 14 Floors |
| Machine-room Option | Yes |
| Entrances | 1 Front 2 Open through 2 Front & side |
| Drive System | Regulated gearless (180 stars per hour) |
| Controller | ARCA III controller, low energy consumption multiprocessor |
| Door Types | Automatic side-opening / Automatic centre-opening / Semiautomatic + Articulated (BUS) |
| Clear door opening | From 500 to 900 mm |
| Door Height | 2,000 / 2,100 / 2,200 mm |
| Car Dimensions | Parametric |
| Internal Car Height | 2,100 / 2,300 mm |

1 Entrance

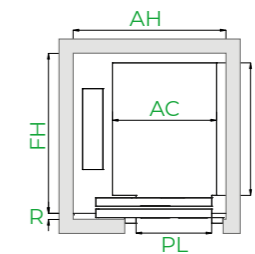

2 Entrances (open through)

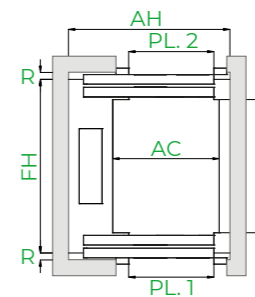

2 Entrances (front & side)

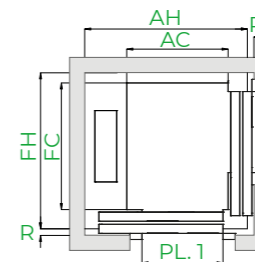

Vertical section

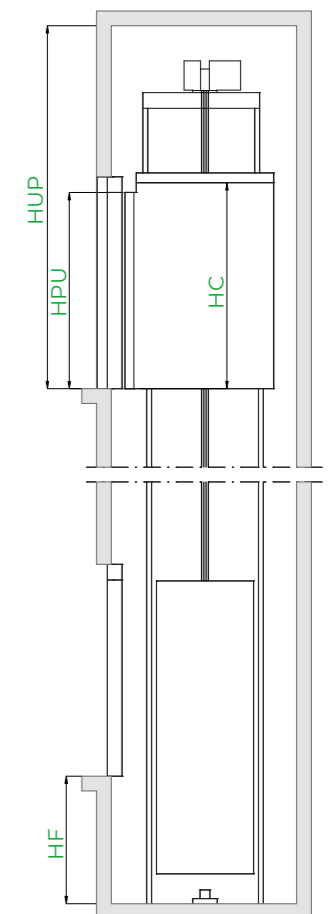

1 Drive
Compact, quiet, gearless, energy-efficient, inverter-drive permanent-magnet motor electrical machine.
✔️🌱



2 Machine room
Simplifies lift maintenance operations thanks to the space available in the room.
✔️



3 Robust lift car
Provides greater lift comfort, reducing vibration and noise during lift travel.
✔️



4 Accessible space below the pit
Adapts the lift to suit buildings requiring an accessible space below the pit (optional).
📄✔️



5 Travel time
Special solution for buildings with long travel times.
📄

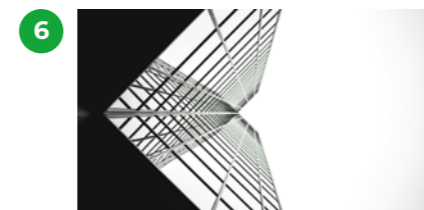

6 Speed
Solution that reaches a greater speed, offering quicker trips for long travel times.
📄



7 Cars
Special car dimensions, with extra depth and wider doors. Designed with reinforced panels and floors for multiple and intensive uses.
♿️



8 Automatic rescue system
With floor level indication to ensure fast, efficient and safe evacuation of passengers in the event of an emergency. As an option, the system can incorporate a fully-automatic rescue device to evacuate passengers in the event of a power failure.
♿️✔️

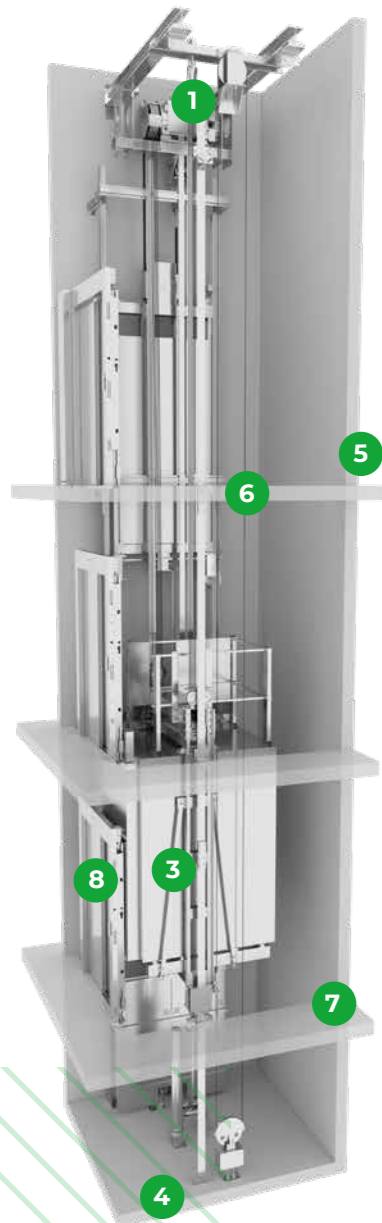

*Note: The diagrams are for guidance only.

Options

| | Next Essentia | Next Smart | Next Smart+ | Next Rise | Next Flex |
|--|------------------|---------------|----------------|--------------|--------------|
| Eco-efficiency | | | | | |
| Low-energy drive | ● | ● | ● | ● | ● |
| Efficient LED lighting | ● | ● | ● | ● | ● |
| Automatic car lighting switch off | ● | ● | ● | ● | ● |
| Landing illumination control | ○ | ○ | ○ | ○ | ○ |
| Lift stand-by mode | ○ | ○ | ○ | ○ | ○ |
| Adaptability | | | | | |
| Flexible controller location | ○ | ○ | ○ | ○ | ○ |
| Lift well enclosure | ○ | ○ | ○ | ○ | ○ |
| Reduced headroom (with safety space) | ○ | ○ | | | |
| Reduced pit (with safety space) | ○ | ○ | | | ○ |
| Accessible space below the pit | ○ | ○ | ○ | ○ | ○ |
| Single-phase supply | ○ | | | | ○ |
| Control and safety | | | | | |
| Evacuation | | | | | |
| Autodialler system | ● | ● | ● | ● | ● |
| Automatic rescue system | ○ | ○ | ○ | ○ | ○ |
| Behaviour of lifts in the event of fire (EN 81-73) | ○ | ○ | ○ | ○ | ○ |
| Connection to auxiliary power source (generator) | ○ | ○ | ○ | ○ | ○ |
| Pit water detector | ○ | ○ | ○ | ○ | ○ |
| Safety landing call cancelling | ○ | ○ | ○ | ○ | ○ |
| Firefighters lift (EN 81-72) | | ○ | ○ (>1,000kg) | ○ | |
| Access control | | | | | |
| Zone cancelling, coded call | ○ | ○ | ○ | ○ | ○ |
| Compulsory stop at main floor | ○ | ○ | ○ | ○ | ○ |
| External call cancelling | ○ | ○ | ○ | ○ | ○ |
| Automatic car call deletion | ○ | ○ | ○ | ○ | ○ |
| Independent entrance selection | ○ | ○ | ○ | ○ | ○ |
| Non-emergency outage | ○ | ○ | ○ | ○ | ○ |
| Emergency outage | ○ | ○ | ○ | ○ | ○ |
| Anti-vandalism (EN 81-71) | | ○ | ○ | ○ | |
| Communications | | | | | |
| Pre-opening doors | ○ | ○ | ○ | ○ | ○ |
| Down collective control | ○ | ○ | ○ | ○ | ○ |
| Full collective control | ○ | ○ | ○ | ○ | ○ |
| Intercom system | ○ | ○ | ○ | ○ | ○ |

Design your own space, because first impressions count.

Quality involves fighting time to maintain the aesthetics and functionality of the lift for as long as possible. And the only way to respond to this challenge is through smart design and excellent quality materials. When a person enters our lifts, this condition must be present throughout their trip, which is why Orona offers different ambiances. All good things last longer.

HARMONIA

Ambiances inspired by natural elements, transmitting peace and serenity.



INNOVA

Innovation applied to design, offering refreshing trips that are full of energy.



RINACCIA

Ambiances based on timeless elements of contemporary architecture, offering an elegant experience.

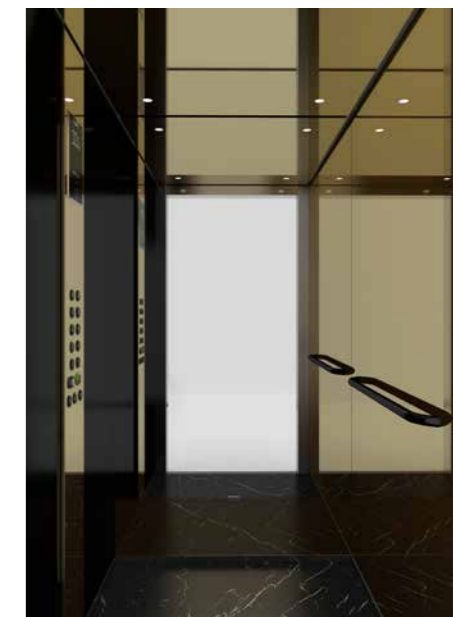

* In order to validate these options please consult with us.

● Standard ○ Optional

